

USER MANUAL

DL30B Digital Lock with Voice Guide Feature

Version: 1.1

Date: July, 2017

Contents

Safety Precautions	1
Structure.....	2
User Introduction	3
Operation and Voice Prompt	4
Initialization.....	4
Random Password	5
Voice Guide	5
Normal Open	6
Low Battery Alarm.....	6
Volume.....	6
9V External Battery.....	7
Emergency Mechanical Key	8
Register First Administrator	9
Register Another Administrator	10

Register Normal User	12
Delete by User Number	14
Delete Administrator Group	16
Delete Normal User Group	17
Supplemental Register	18
Enable Normal Open	19
Volume	20
Mute Function	21
Open the Door with Password	22
Open the Door with Card	22

Read Before Use

Safety Precautions

1. The default setting of the lock allows **any** password/card to unlock it.
2. Please register at least one administrator for the newly installed lock. Without administrator, registration for any normal user is not allowed.
3. The lock comes with mechanical keys for manual unlocking. Please keep the mechanical keys at a safe place.
4. To Power On the lock, four alkaline AA batteries (not included) are required. Non-alkaline and rechargeable batteries **are not recommended**.
5. Do not remove batteries when the lock is in working state.
6. Please replace the battery soon when the lock prompts the voice of low battery.
7. There are 7 seconds stand-by time limits for all setting operations, without any activity within the time limits, the lock will automatically shut off.

Structure

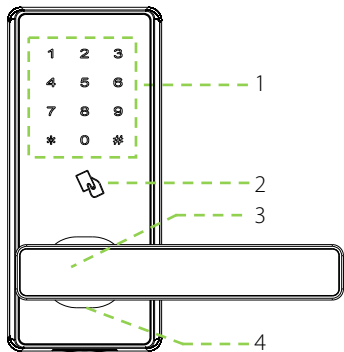

1. Keypad Area
2. Card Detection Area
3. Handle
4. Mechanical Key Hole
5. 9V battery Interface
6. Battery Area
7. Reset Button

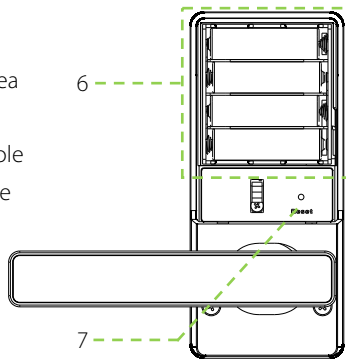
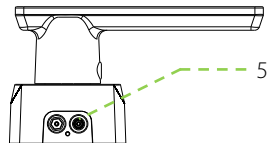

Basic Functions

User Introduction

User	Verification Mode	Function
Administrator	Password	Menu Operation, Open The Door
	ID Card	
Normal User	Password	Open The Door
	ID Card	

Note:

- 1) The maximum capacity of password or ID card is 100.
- 2) The length of password is 6 digits.

Operation and Voice Prompt

Operation	Voice Prompt
Verification Succeeded	"Thank you"
Verification Failed	"Verification Failed"
Registration Succeeded	"Registered"
Deletion Succeed	"Deleted"
Registration Failed	"Operation Failed"
Password has already registered	"This password is already used"
ID Card has already registered	"This card is already used"
User Number has already registered	"This user number is already used"

Initialization

Initializing the lock means all data will be deleted and restored to factory default setting.

Operation Instruction: Press the reset button, then touch the keypad to power on the lock, and hold the reset button for 5 seconds until the lock prompts the voice of “Restore to default settings, wait a moment”. After around 30 seconds, the lock prompts the voice of “completed”, and then the initialization is finished.

Random Password

Random password = random digits + correct password + random digits.

Users may enter any random digits before or after the correct password to create random password to open the door. The maximum length of the random password is 32 digits.

For example: If the correct password is 123456, the random password can be 891123456807, 1234562363, 3891123456, etc.

Voice Guide

After accessing the menu, the lock will prompt voice before/after each operation. It is quite easy for user to know how to operate each step.

Normal Open

Normal open mode is to keep lock always unlocked, which is fit for meeting room and some places where in or out is not restricted.

Low Battery Alarm

When the lock is in low battery status, it will trigger the alarm with the sound of short beep and the voice of "Battery is low, please replace". After triggering low battery alarm, the lock will be shut down after approx. 200 operations.

Note: Access to operation steps is not allowed in low battery status.

Volume

Users can set volume level in accordance with individual preference and requirement. The default volume level is 3 and the adjustable range is 0-7.

9V External Battery

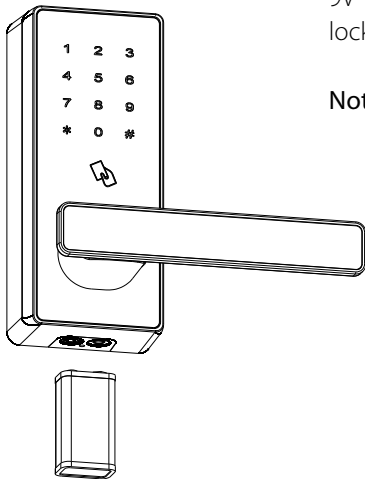

9V external battery is used to open door when the lock is not operating through battery.

Note: The battery must be 9V alkaline battery (6LR61).

Emergency Mechanical Key

The mechanical key is used to open door when the lock has an electronic malfunction.

Note: Keep the mechanical key at a safe place.

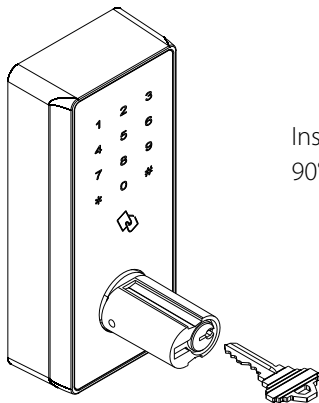

Insert the key into key hole and rotate 90° in clockwise direction.

How to Use

Register First Administrator

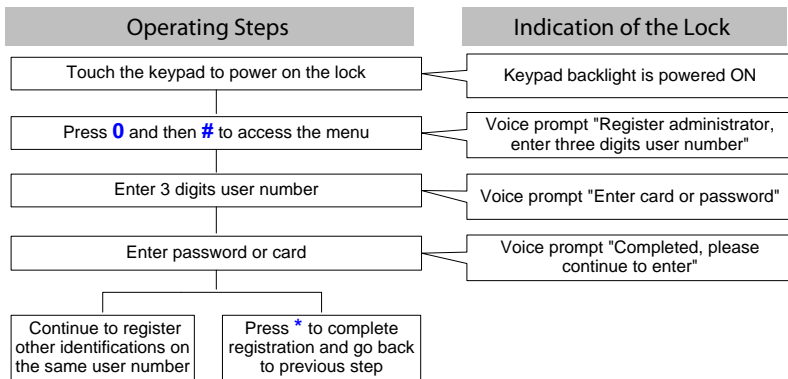

Note:

- 1) Enter the password twice to register.
- 2) The length of password is 6 digits.
- 3) The regular length of user number is 3 digits. However, it can also be entered as 1 digit or 2 digits with the end of **#** as the user number. For example, **001** is equal to **1#** or **01#**.
- 4) Press ***** to cancel the registration, if needed in between of the registration.

Register Another Administrator

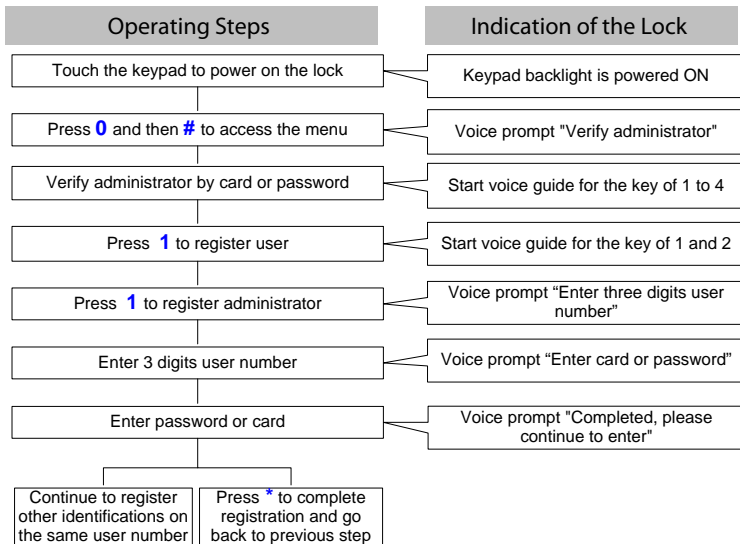

Note:

- 1) Enter the password twice to register.
- 2) The length of password is 6 digits. When verifying administrator by password, press # to end.
- 3) The regular length of user number is 3 digits. However, it is also correct to enter 1 digit or 2 digits with the end of # as the user number. For example, **001** is equal to **1#** or **01#**.
- 4) Press * to cancel the registration, if needed in between of the registration.

Register Normal User

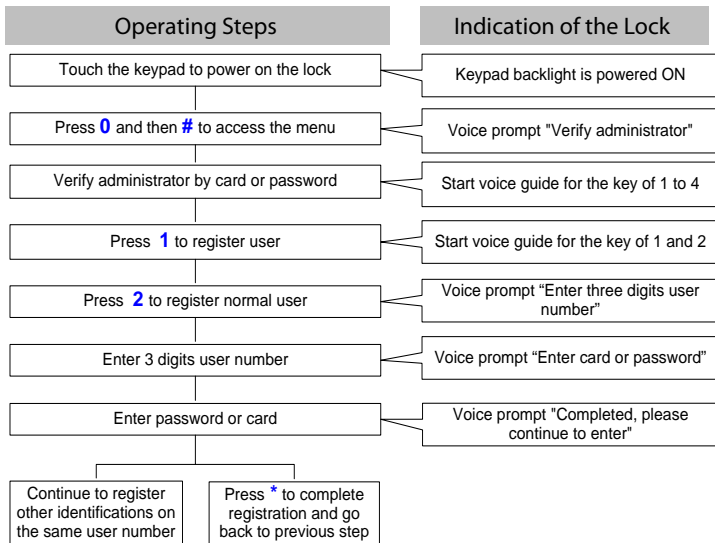

Note:

- 1) Enter the password twice to register.
- 2) The length of password is 6 digits. When verifying administrator by password, press # to end.
- 3) The regular length of user number is 3 digits. However, it is also correct to enter 1 digit or 2 digits with the end of # as the user number. For example, **001** is equal to **1#** or **01#**.
- 4) Press * to cancel the registration, if needed in between of the registration.

Delete by User Number

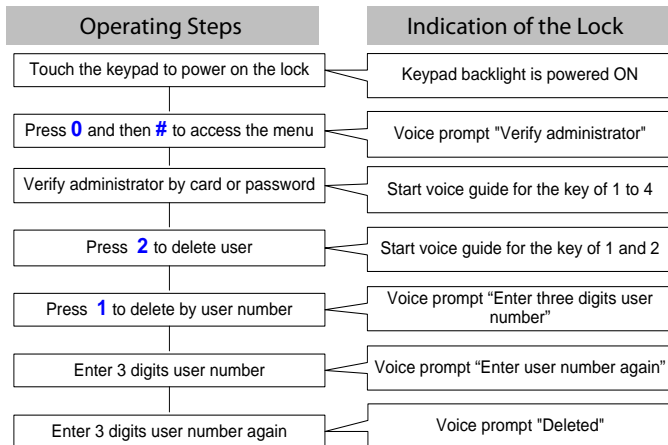

Note:

- 1) The regular length of user number is 3 digits. However, it can also be entered as 1 digit or 2 digits with the end of # as the user number. For example, **001** is equal to **1#** or **01#**.
- 2) When verify administrator by password, press # to end.
- 3) Press * to cancel the registration, if needed in between of the registration.

Delete Administrator Group

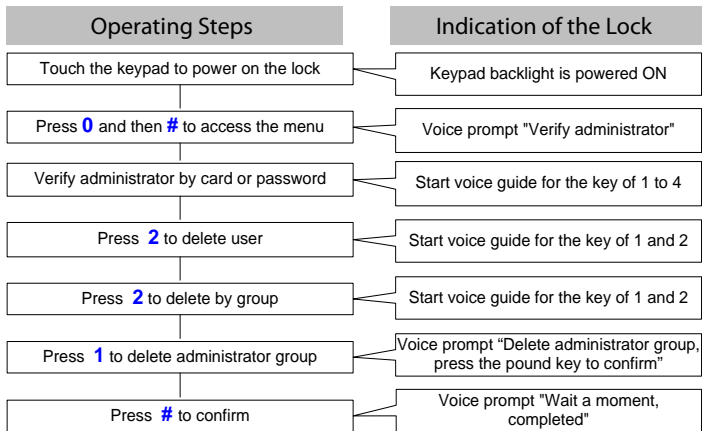

Note:

- 1) When verifying administrator by password, press **#** to end.
- 2) Press ***** to cancel the registration, if needed in between of the registration.

Delete Normal User Group

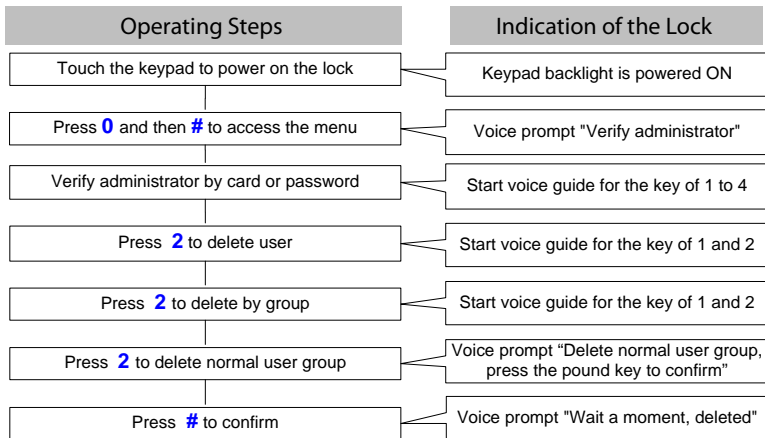

Note:

- 1) When verifying administrator by password, press **#** to end.
- 2) Press ***** to cancel the registration, if needed in between of the registration.

Supplemental Register

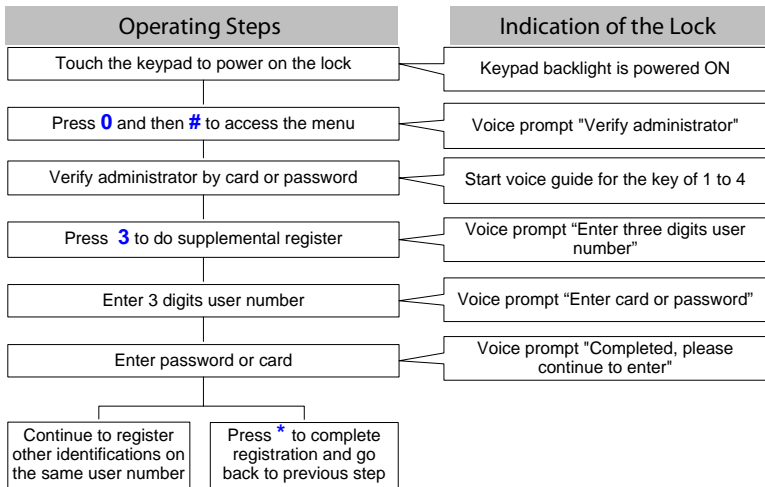

Note:

- 1) The regular length of user number is 3 digits. However, it is also correct to enter 1 digit or 2 digits with the end of **#** as the user number. For example, **001** is equal to **1#** or **01#**.
- 2) When verifying administrator by password, press **#** to end.

Enable Normal Open

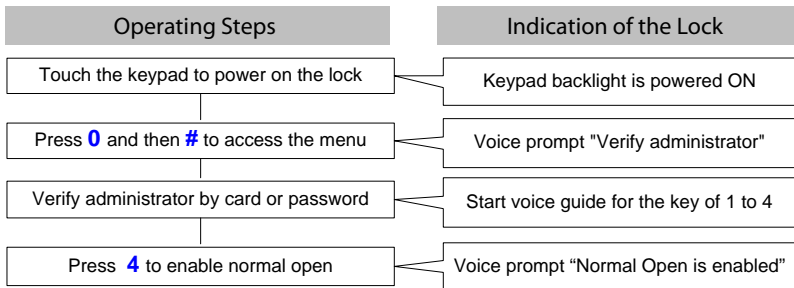

Note:

- 1) To disable normal open, please use any registered card / password to unlock the door.
- 2) When verifying administrator by password, press **#** to end.

Volume

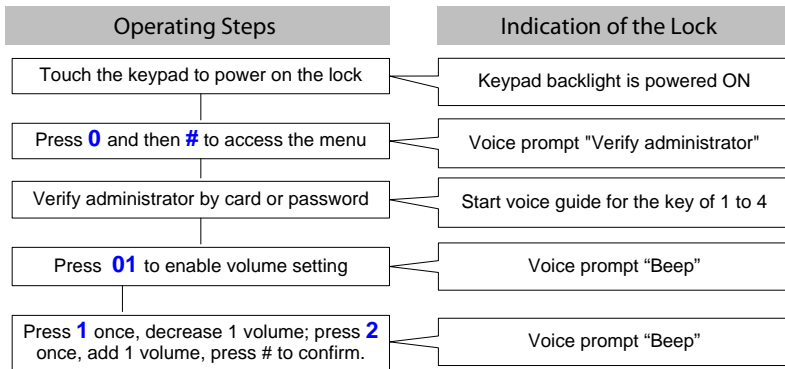

Note:

- 1) The volume of the "Beep" is the current volume.
- 2) When verifying administrator by password, press **#** to end.

Mute Function

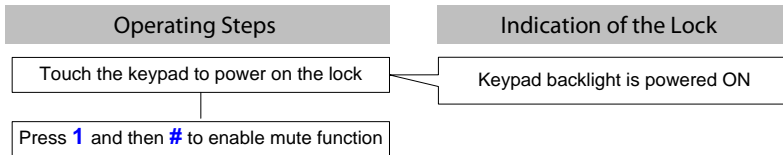

Note:

- 1) After enable the mute function, no sound prompt for all operations on the keypad.
- 2) To disable the mute function, press **1** and then **#** again after the keypad backlight is powered on again.

Quick Start

Open the Door with Password

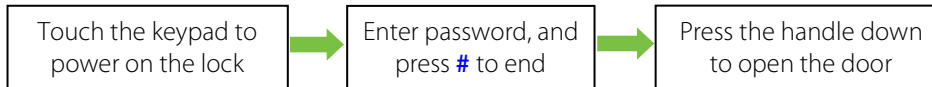

Note: User may enter random password to prevent any person beside from observing the password. The maximum length of the random password is 32 digits.

Open the Door with Card

